

Varenummer: 23110111014
Beskrivelse: E+G Vertikal oliestandsglas
HCK.127-GL-M12, for glycol-baserede løsninger

Mål

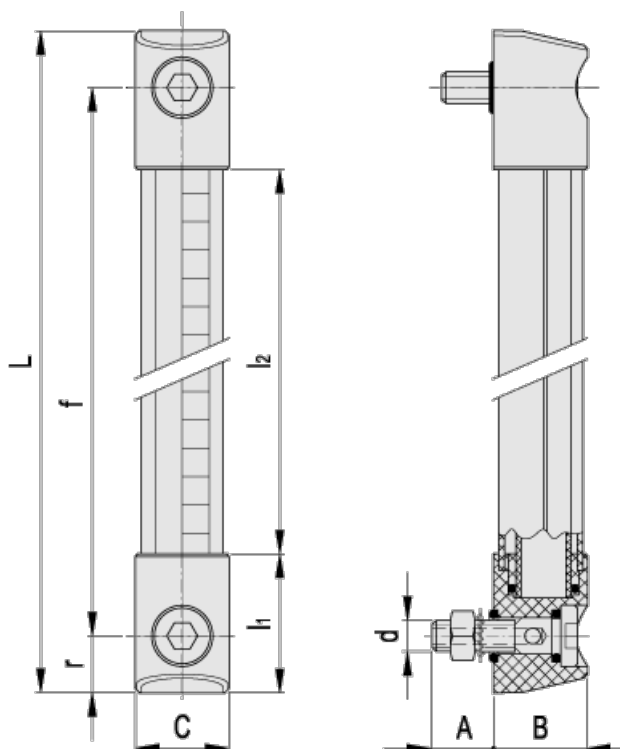

A = 20

r = 18.5

B = 33

C = 33

d = M12

f = 127

L = 164

l1 = 46.5

l2 = 71